



深圳市瑞欣峰电子科技有限公司

Shenzhen Ruixinfeng Electronics Technology co.,LTD

Φ5 塑封脉冲 25W 激光二极管

一、产品信息

产品型号	发光区数量	峰值功率	典型波长
RXF-905-25W-SE	3	25W	905nm

二、产品说明 **Product explanation**

Features:

- Multi-epitaxial luminous layer stack structure
- The luminous aperture is 84μm by 10μm
- Large optical cavity LOC high power material structure
- Narrow light speed divergence angle
- High laser power density

特点:

- 多外延发光层堆叠结构
- 发光孔径 84μm×10μm
- 大光腔 LOC 高功率材料结构
- 窄光束发散角
- 激光功率密度高

application

- Laser rangefinder.
- traffic surveillance and vigilance.
- infrared illumination.
- Laser radar.

应用

- 激光测距仪
- 交通监视与警戒
- 红外照明
- 激光雷达

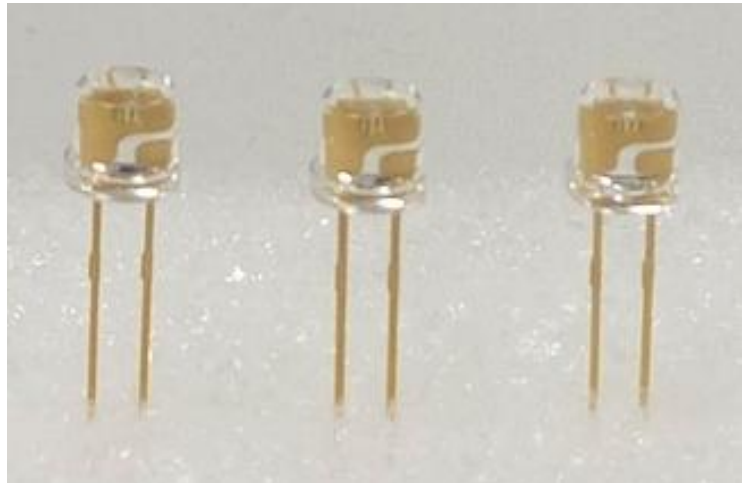



产品型号：脉冲激光二极管

RXF-905-25W-SE

版本 Edition:A/3

三、产品外形尺寸 Product outline dimension drawing

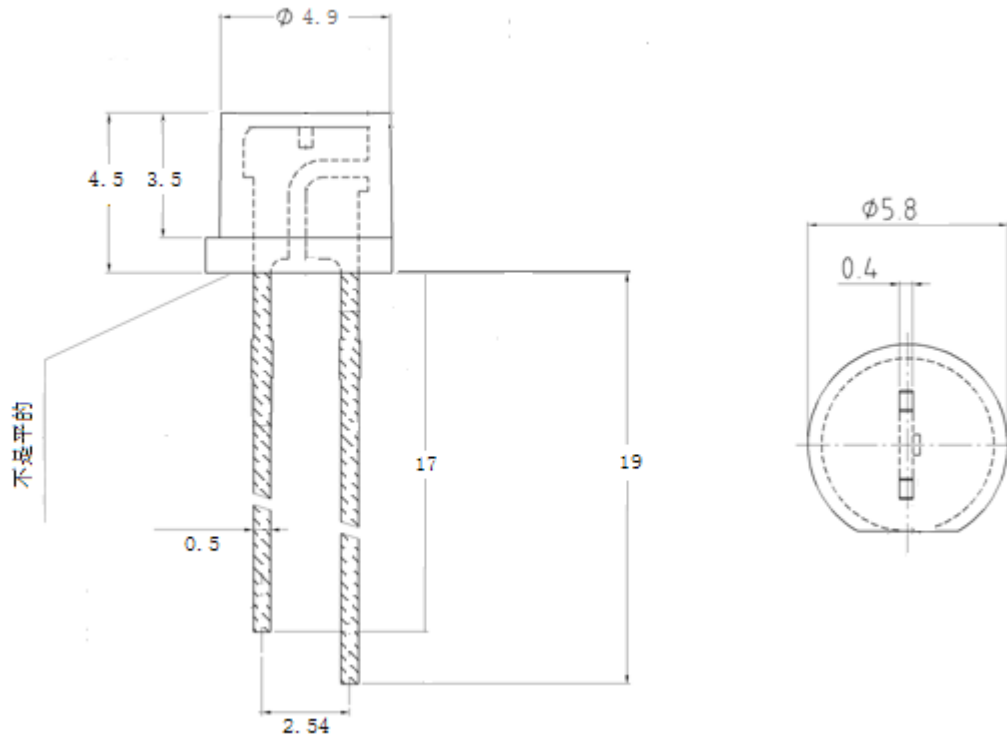

说明 Explanation:

1. 封装胶体是环氧树脂; Encapsulated colloids are epoxy resin
2. 引线框架是镀金黄铜; The lead frame is gold-plated brass
3. 引脚定义长正短负; Pin definition is short and negative.
4. 所有产品尺寸用毫米; All product sizes are in mm
5. 产品允许误差为 $\pm 0.25\text{mm}$; The allowable error of the product is plus or minus 0.25mm
6. 胶体边缘溢胶最高不超过 0.2 mm; colloid edge overflows the rubber to be highest does not surpass 0.2mm
7. 胶体边缘缺胶最高不超过 0.4mm; colloid edge lacks the rubber to be highest does not surpass 0.4mm;
8. 从包装中取出时注意支架脚, 以免划伤; Pay attention to the legs of the brackets to avoid scratches when taken out of the packaging;



产品型号：脉冲激光二极管

RXF-905-25W-SE

版本 Edition:A/3

四、产品参数与特性图 Product parameters and feature maps

4.1 最大额定数据 (测试温度为 25℃) : Maximum rated data (test temperature is 25 °C)

项目 Symbol	说明 Explanation	数值 Value	单位 Unit
P_{peak}	输出功率 Peak output power	30	W
V_{op}	工作电压 Operating voltage	7.0	V
I_{op}	工作电流 Operating current	9	A
t_p	脉冲宽度 Pulse width (FWHM)	200	ns
dC	工作周期占空比 Duty cycle	0.1	%
T_{OPR}	工作温度范围 Operating Temperature Range	-15℃ to 65℃	
T_{op}	储存温度范围 Storage Temperature Range	-40℃ to 100℃	
E_{sd}	防静电电压 ESD Voltage	≥500V	
T_s	焊接温度 Welding temperature	≤260°	

4.2 电性参数(测试温度为 25℃) : Electrical BDmeter(test temperature for 25℃)

项目 Symbol	说明 Explanation	最小值 Min	典型值 Type	最大值 Max	单位 Unit
λ_{peak}	发射波长 Emission wavelength	895	905	915	nm
FWHM	光谱宽度 Spectral width	-	4	-	nm
I_{th}	阈值电流 Threshold current		0.5		A
$\theta_{ }$	平行光束发散角 Beam divergence (FWHM) parallel to pn-junction	-	12	-	°
θ_{\perp}	垂直光束发散角 Beam divergence (FWHM) perpendicular to pn-junction	-	25	-	°
P_{peak}	峰值输出功率 Peak output power		25	30	W
$\Delta\lambda / \Delta T$	波长的温度系数 Wavelength of temperature coefficient	-	0.28	-	nm / K
w_h	发光面积 Light emitting area	-	84x10	-	μ m

All characteristics refer to pulsed measurements (200 ns pulse width at 5 kHz repetition rate).

所有特征都是指脉冲测量(200 ns 脉冲宽度，5 kHz 重复频率)。



产品型号：脉冲激光二极管

RXF-905-25W-SE

版本 Edition:A/3

4.3 产品特性图 Product characteristic chart:

Fig.1 峰值功率 VS 正向电压 VS 正向电流
 $T_A = 25\text{ }^\circ\text{C}$

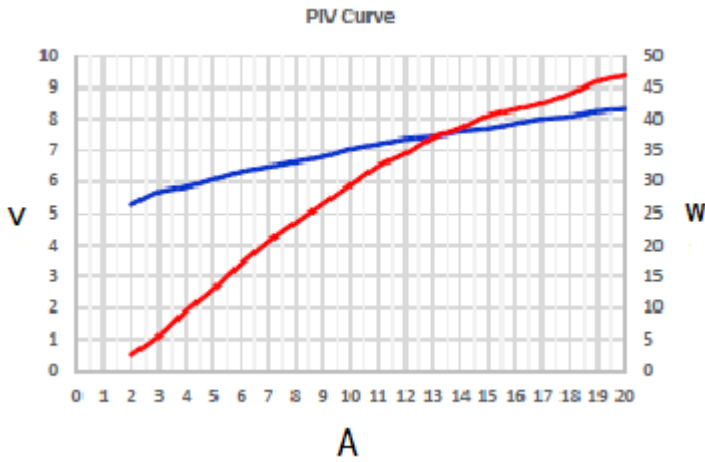

Fig. 2 发射峰值波长 $T_A = 25\text{ }^\circ\text{C}$,

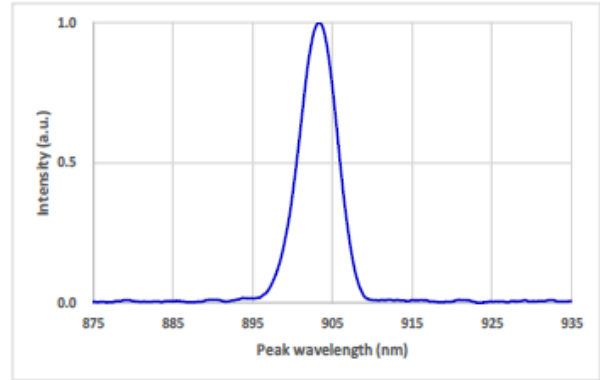

Fig.3 垂直发散角度 θ_{\perp} $T_A = 25\text{ }^\circ\text{C}$,

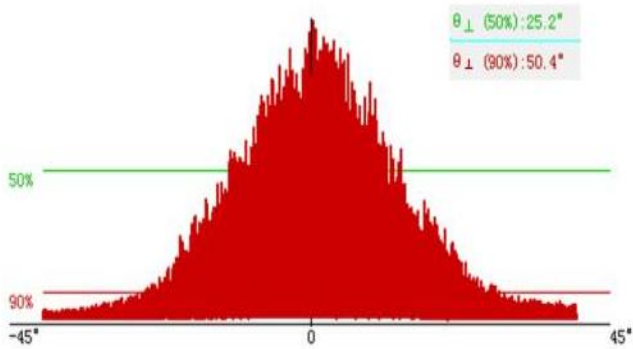

Fig. 4 平行发散角度 θ_{\parallel} $T_A = 25\text{ }^\circ\text{C}$,

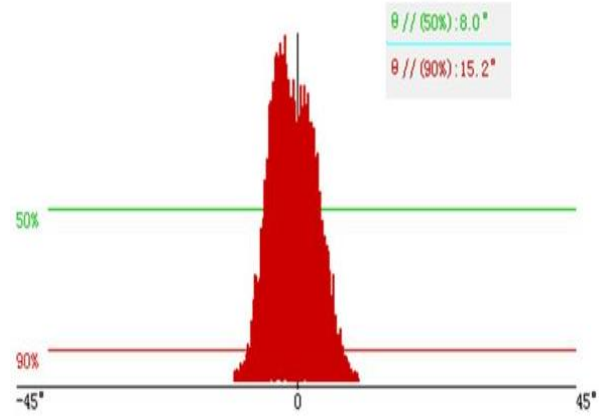

Fig. 5 波长温度曲线

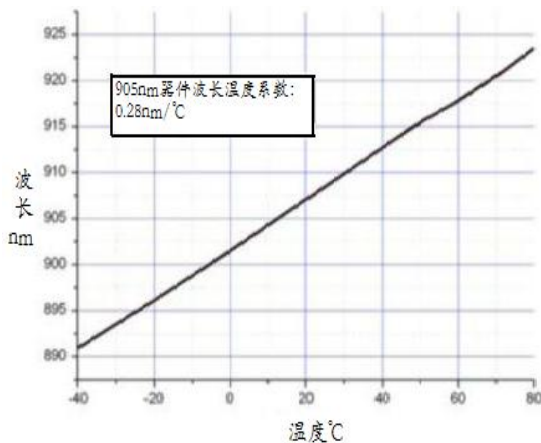

Fig. 6 近场光斑图





产品型号：脉冲激光二极管

RXF-905-25W-SE

版本 Edition:A/3

五、使用注意事项 precautions

Precaution

- The laser light emitted from this laser diode is invisible and may be harmful to the human eye. Avoid looking directly into the diode laser or into the collimated beam along its optical axis when the device is in operation.
- In its maximum rating diode laser operation could damage its performance or cause potential safety hazard such as equipment failure
- Electrostatic discharge is the main reason for the laser fault of the diode. Take effective precautions against ESD. When dealing with laser diodes, use the wrist strap, grounding work surface and strict antistatic technology.

预防措施

- 此激光二极管发出的激光是看不见的，可能对人的眼睛造成伤害。当激光二极管处于工作状态时，要避免直接观察半导体激光器或在其光轴上的平行光束。
- 在其最大额定值外操作二极管激光器可能会破坏其性能或导致设备故障等安全隐患。
- 静电是导致激光二极管故障的主要原因。采取有效的预防措施防止 ESD。在使用激光二极管时，要使用防静电手腕带、接地工作台面和其它抗静电措施。



产品采购与服务

联系人：杨保

电话：0755-29163600、29163800

传真：0755-29163900

地址：中国 深圳市宝安区西乡街道固戍开发区庄边工业园 D 栋 5 楼