

## 650nm Red Laser Diode RLD65000503

(1) Device: Laser Diode

(2) Structure: TO-18(  $\phi$  5.6mm), With Pb free glass cap, PD

■ External dimensions(Unit : mm)

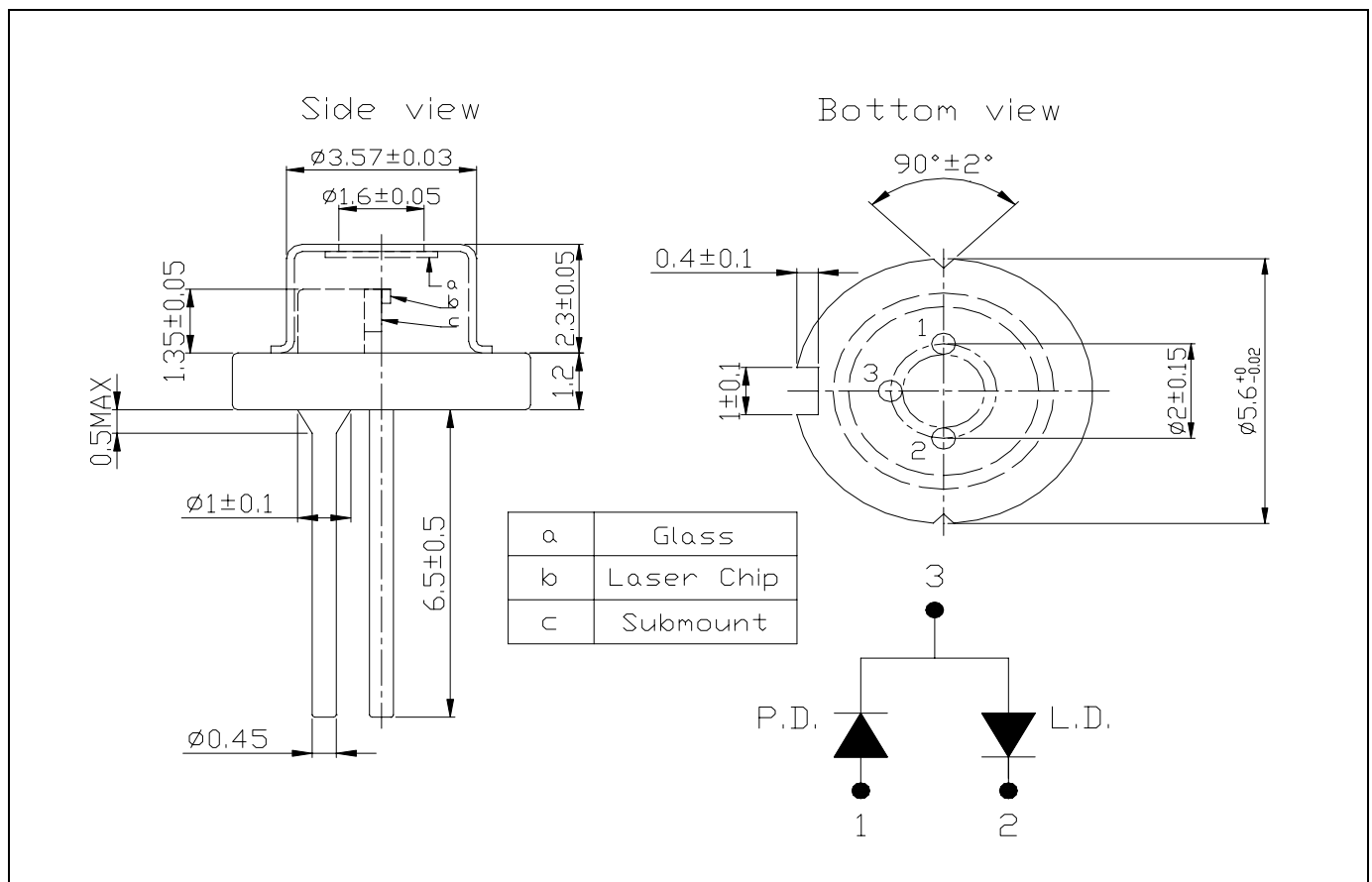

### ■ Absolute Maximum Ratings( $T_c=25^{\circ}\text{C}$ )

Parameter	Symbol	Value	Unit	
Optical Output	$P_o$	5	mW	
Reverse Voltage	Laser	$V_r$	2	V
	PIN PD	$V_r(\text{PIN})$	30	V
Operating Temperature	Top	-10~+40	$^{\circ}\text{C}$	
Storage Temperature	Tstg	-15~+85	$^{\circ}\text{C}$	

### ■ Electrical and Optical Characteristics(Tc=25°C)

Parameter	Symbol	Condition	Min.	Typ.	Max.	Unit	
Threshold Current	I <sub>th</sub>	P <sub>o</sub> =5mW	-	12	25	mA	
Operating Current	I <sub>op</sub>	P <sub>o</sub> =5mW	-	18	25	mA	
Operating Voltage	V <sub>op</sub>	-	-	2.1	2.5	Volt	
Slope Efficiency	$\eta$	4mW-1mW	0.4	0.8	-	mW/mA	
		I <sub>4mW</sub> -I <sub>1mW</sub>					
Monitor Current	I <sub>m</sub>	P <sub>o</sub> =5mW	0.05	0.3	0.5	mA	
Beam Divergence (FWHM)	Parallel	$\theta //$	P <sub>o</sub> =5mW	5	9	12	deg.
	Perpendicular	$\theta \perp$	P <sub>o</sub> =5mW	30	36	42	deg.
Lasing Wavelength	$\lambda$	P <sub>o</sub> =5mW	640	655	660	nm	

◎  $\theta //$  and  $\theta \perp$  are defined as the angle within which the intensity is 50% of the peak value.

### ■ Typical characteristic curves

#### Optical Output Power v.s. Forward Current

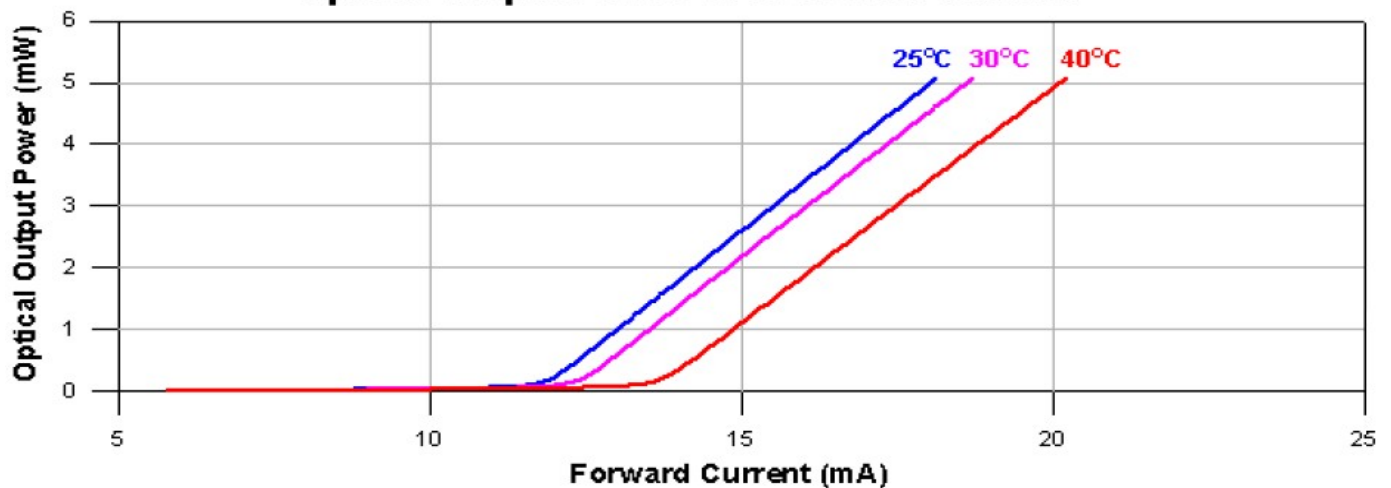

#### Forward Voltage v.s. Forward Current

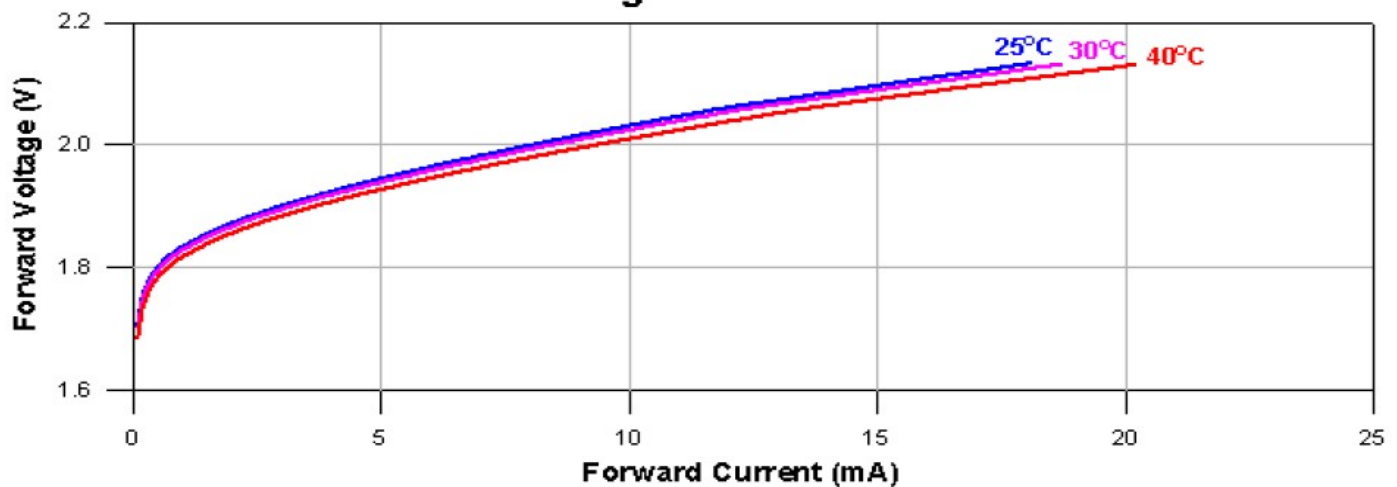

**Peak Wavelength v.s. Case Temperature**

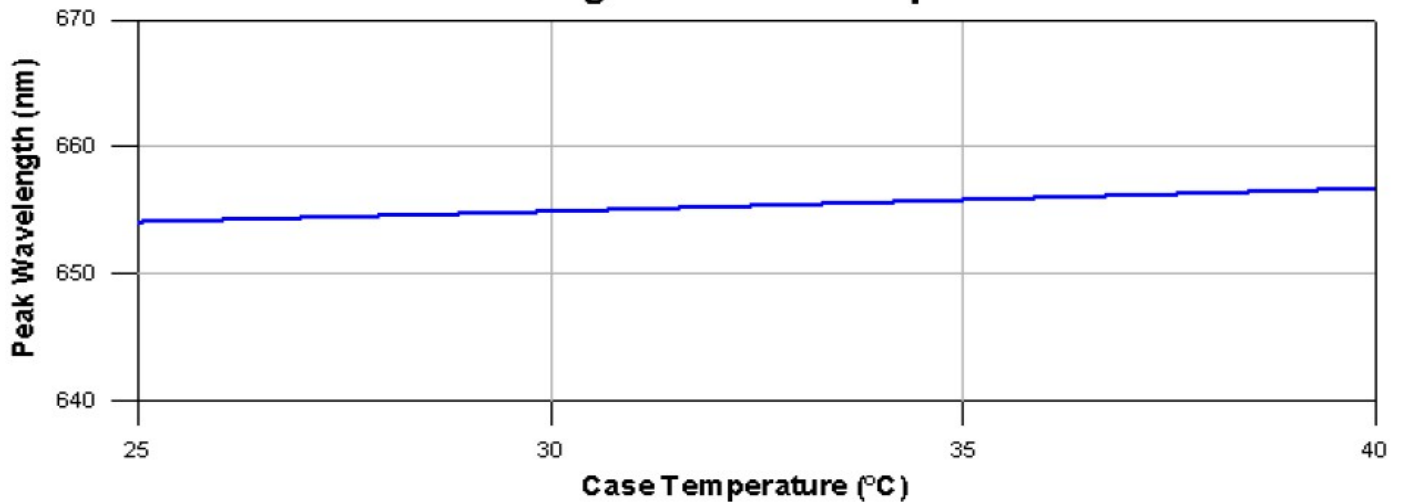

**Far-Field Pattern**

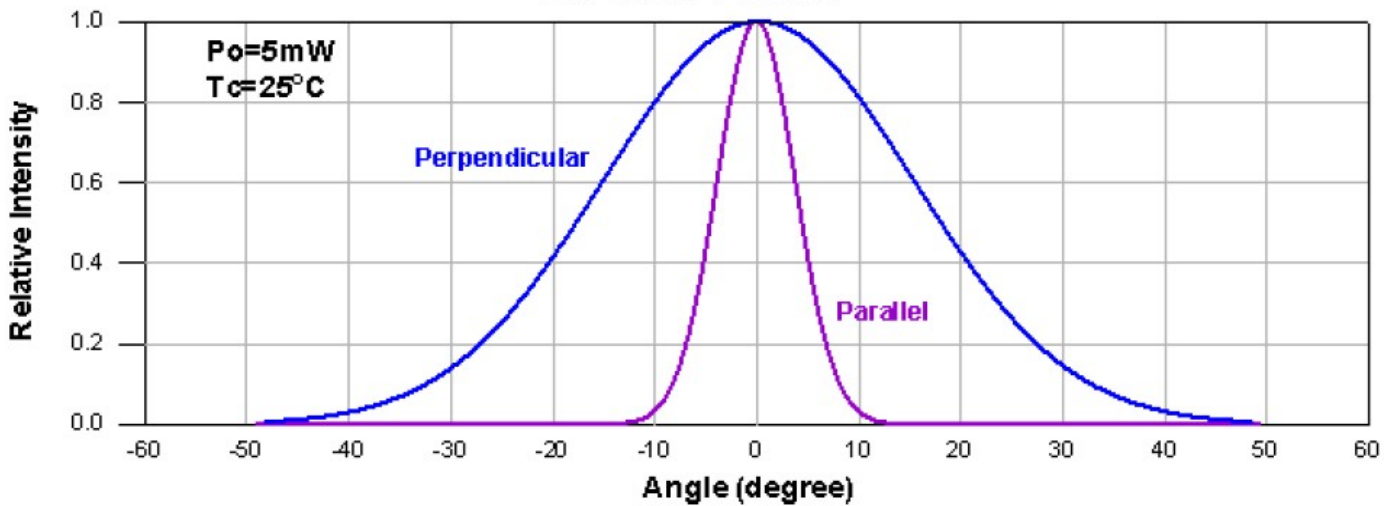

**Monitor Current v.s. Optical Output Power**

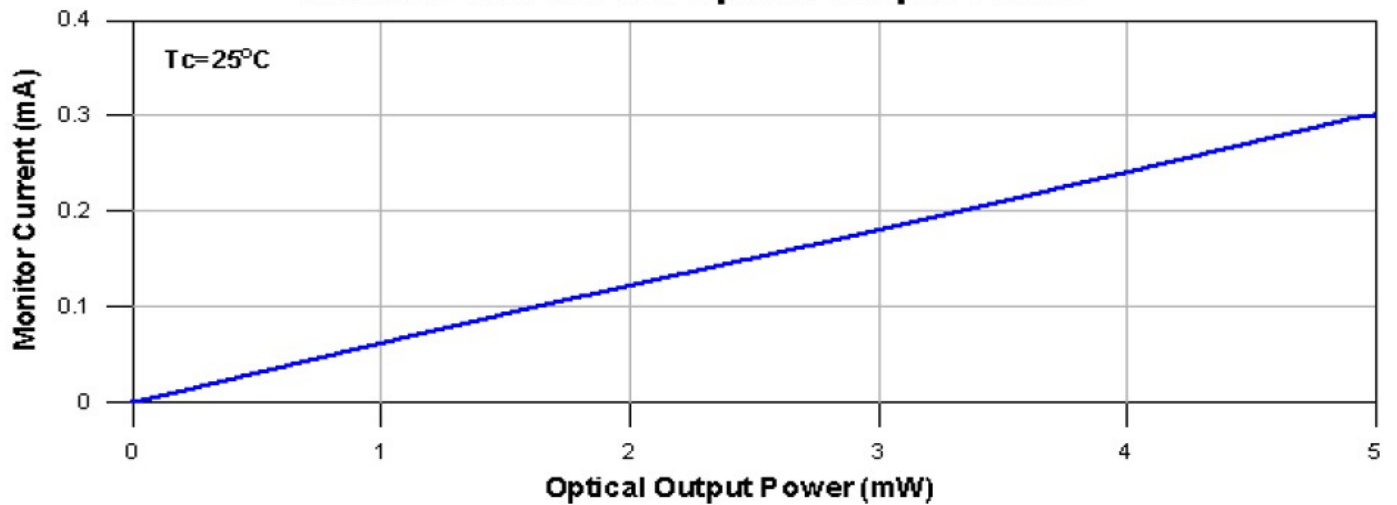

**Slope Efficiency v.s. Case Temperature**

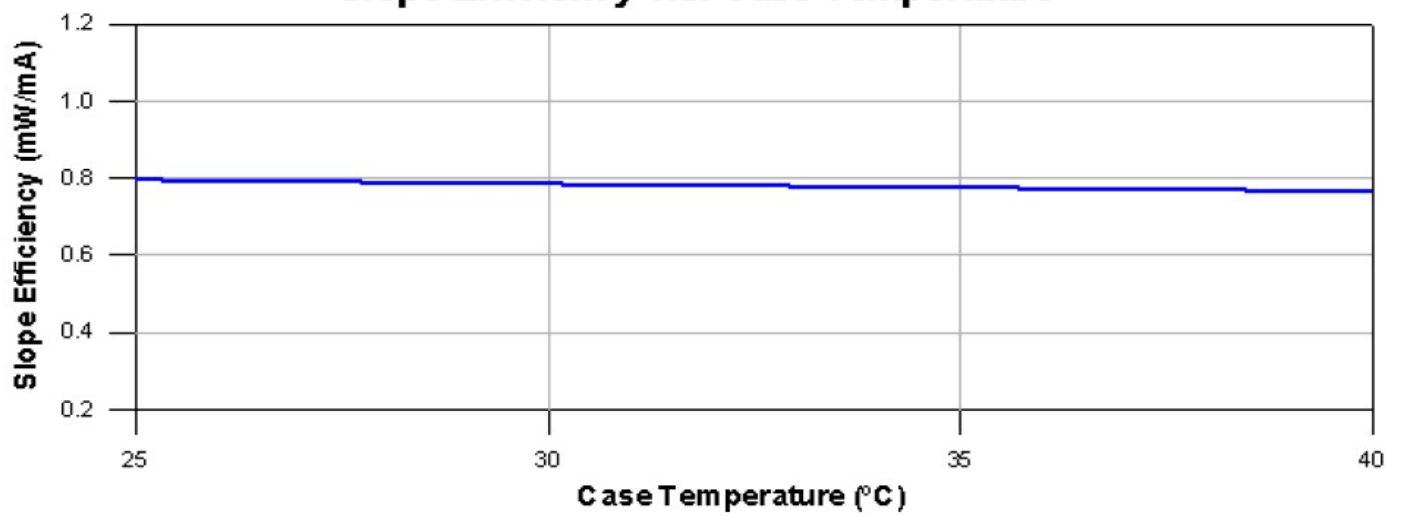

**Threshold Current v.s. Case Temperature**

